

FIJACIÓN



REMACHES



ALA ESTANDAR1



ALA ANCHA1

CHAVETAS



CHAVETAS.....2

ANCLAS Y TAQUETES



TAQUETE PARA
TABLAROCA3



ANCLA ROSCADA
PARA MURO FALSO..... 3



TAQUETE
EXPANSOR Z.....3



TAQUETE EXPANSOR..... 3



TAQUETE DE GOLPE.....3



PUNZÓN PARA
TAQUETE3



ANCLA CAMISA.....3

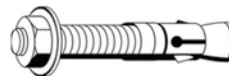

ANCLA ARPÓN.....4

REMACHES

CLAVE	DESCRIPCION	E
REMACHES DE CLAVO		
ALUMINIO/ACERO		
ALA ESTÁNDAR		



FR41	D: 1/8 L: 3/16 A: 1/16	1,000
FR42	D: 1/8 L: 1/4 A: 1/8.	1,000
FR43	D: 1/8 L: 5/16 A: 3/16.	1,000
FR44	D: 1/8 L: 3/8 A: 1/4.	1,000
FR45	D: 1/8 L: 7/16 A: 5/16.	1,000
FR46	D: 1/8 L: 1/2 A: 3/8.	1,000
FR48	D: 1/8 L: 5/8 A: 1/2.	1,000
FR410	D: 1/8 L: 3/4 A: 5/8.	1,000

FR52	D: 5/32 L: 1/4 A: 1/8.	1,000
FR54	D: 5/32 L: 3/8 A: 1/4.	1,000
FR56	D: 5/32 L: 1/2 A: 3/8.	500
FR58	D: 5/32 L: 5/8 A: 1/2.	500
FR510	D: 5/32 L: 3/4 A: 5/8.	500
FR512	D: 5/32 L: 7/8 A: 3/4.	500

FR62	D: 3/16 L: 1/4 A: 1/8.	500
FR64	D: 3/16 L: 3/8 A: 1/4.	500
FR66	D: 3/16 L: 1/2 A: 3/8.	500
FR68	D: 3/16 L: 5/8 A: 1/2.	500
FR610	D: 3/16 L: 3/4 A: 5/8.	250
FR612	D: 3/16 L: 7/8 A: 3/4.	250
FR614	D: 3/16 L: 1" A: 7/8.	250
FR616	D: 3/16 L: 1.1/8 A: 1".	250

FR84	D: 1/4 L: 3/8 A: 1/4.	400
FR86	D: 1/4 L: 1/2 A: 3/8.	350
FR88	D: 1/4 L: 5/8 A: 1/2.	300

CLAVE	DESCRIPCION	E
REMACHES DE CLAVO		
ALUMINIO/ACERO		
ALA ANCHA		



FRL64	D: 3/16 L: 3/8 A: 1/4.	500
FRL66	D: 3/16 L: 1/2 A: 3/8.	250
FRL68	D: 3/16 L: 5/8 A: 1/2.	250
FRL610	D: 3/16 L: 3/4 A: 5/8.	250
FRL612	D: 3/16 L: 7/8 A: 3/4.	250

D: DIAMETRO
L: LARGO
A: AGARRE

CHAVETAS

CLAVE	DESCRIPCION	E
CHAVETAS		
		

FC01013	1/16X1/2	800
FC01019	1/16X3/4	400
FC01025	1/16X1	300
FC01032	1/16X1.1/4	200
FC01038	1/16X1.1/2	100
FC01051	1/16X2	100

FC02013	3/32X1/2	300
FC02019	3/32X3/4	200
FC02025	3/32X1	100
FC02032	3/32X1.1/4	100
FC02038	3/32X1.1/2	100
FC02051	3/32X2	50

FC03013	1/8X1/2	250
FC03019	1/8X3/4	150
FC03025	1/8X1	100
FC03032	1/8X1.1/4	100
FC03038	1/8X1.1/2	100
FC03051	1/8X2	100
FC03064	1/8X2.1/2	50
FC03076	1/8X3	50

FC04013	5/32X1/2	150
FC04019	5/32X3/4	100
FC04025	5/32X1	100
FC04032	5/32X1.1/4	100
FC04038	5/32X1.1/2	100
FC04051	5/32X2	50
FC04064	5/32X2.1/2	50
FC04076	5/32X3	30

CLAVE	DESCRIPCION	E
CHAVETAS		
		

FC05013	3/16X1/2	200
FC05019	3/16X3/4	150
FC05025	3/16X1	150
FC05032	3/16X1.1/4	100
FC05038	3/16X1.1/2	100
FC05051	3/16X2	80
FC05064	3/16X2.1/2	50
FC05076	3/16X3	50
FC05089	3/16X3.1/2	50
FC05102	3/16X4	50

FC06025	1/4X1	150
FC06032	1/4X1.1/4	150
FC06038	1/4X1.1/2	100
FC06051	1/4X2	100
FC06064	1/4X2.1/2	50
FC06076	1/4X3	50
FC06089	1/4X3.1/2	50
FC06102	1/4X4	50

FC08025	5/16X1	100
FC08032	5/16X1.1/4	100
FC08038	5/16X1.1/2	100
FC08051	5/16X2	50
FC08064	5/16X2.1/2	50
FC08076	5/16X3	50
FC08089	5/16X3.1/2	50
FC08102	5/16X4	50

FC09038	3/8X1.1/2	50
FC09051	3/8X2	50
FC09064	3/8X2.1/2	50
FC09076	3/8X3	25
FC09089	3/8X3.1/2	25
FC09102	3/8X4	25

ANCLAS Y TAQUETES

CLAVE	DESCRIPCION	E
TAQUETE AUTOPERFORANTE PARA TABLAROCA 		
F TTL06	Taquete para tablaroca	100

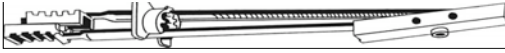
CLAVE	DESCRIPCION	E
ANCLA ROSCADA PARA PANELES 		
F TR05	3/16 - 24.	50
F TR06	1/4-20.	50

CLAVE	DESCRIPCION	E
TAQUETE EXPANSOR Z ZINCADO 		
F TZ05	3/16 - 24	100
F TZ06	1/4-20.	100
F TZ08	5/16-18.	50
F TZ09	3/8-16.	50
F TZ13	1/2-13.	25

CLAVE	DESCRIPCION	E
TAQUETE EXPANSOR 		
F TE06	1/4-20.	50
F TE08	5/16-18.	50
F TE09	3/8-16.	50
F TE13	1/2-13.	25
F TE16	5/8-11.	25
F TE19	3/4-10.	10

CLAVE	DESCRIPCION	E
TAQUETE DE GOLPE 		
F TG06	1/4-20.	100
F TG09	3/8-16.	50
F TG13	1/2-13.	50
F TG16	5/8-11.	25
F TG19	3/4-10.	25

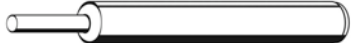
CLAVE	DESCRIPCION	E
PUNZON PARA TAQUETE DE GOLPE 		
F TGP06	1/4.	20
F TGP08	3/8.	10
F TGP13	1/2.	10
F TGP16	5/8.	5
F TGP19	3/4.	5

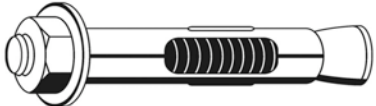
CLAVE	DESCRIPCION	E
ANCLA DE CAMISA 		
F TC06057	1/4 X 2.1/4.	100
F TC08064	5/16 X 2.1/2.	50
F TC09076	3/8 X 3".	50
F TC13076	1/2 X 3".	25

ANCLAS Y TAQUETES

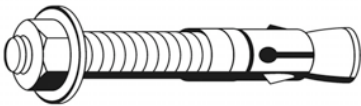
CLAVE	DESCRIPCION	E
ANCLA		
ARPON		

FTA06044	1/4-20 X 1.3/4.	100
FTA06057	1/4-20 X 2.1/4.	100
FTA06076	1/4-20 X 3".	100

FTA08051	5/16-18 X 2".	50
FTA08070	5/16-18 X 2.3/4.	50
FTA08089	5/16-18 X 3.1/2.	50

FTA09057	3/8-16 X 2.1/4.	50
FTA09070	3/8-16 X 2.3/4.	50
FTA09076	3/8-16 X 3".	50
FTA09089	3/8-16 X 3.1/2.	50
FTA09095	3/8-16 X 3.3/4.	50
FTA09127	3/8-16 X 5".	50

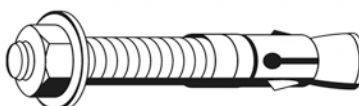
CLAVE	DESCRIPCION	E
ANCLA		
ARPON		

FTA13070	1/2-13 X 2.3/4.	25
FTA13095	1/2-13 X 3.3/4.	25
FTA13114	1/2-13 X 4.1/2.	25
FTA13140	1/2-13 X 5.1/2.	25
FTA13178	1/2-13 X 7".	25

FTA16089	5/8-11 X 3.1/2.	25
FTA16114	5/8-11 X 4.1/2.	20
FTA16127	5/8-11 X 5".	20
FTA16152	5/8-11 X 6".	20
FTA16178	5/8-11 X 7".	20

FTA19108	3/4-10 X 4.1/4.	10
FTA19121	3/4-10 X 4.3/4.	10
FTA19140	3/4-10 X 5.1/2.	10
FTA19158	3/4-10 X 6.1/4.	10
FTA19178	3/4-10 X 7".	10
FTA19216	3/4-10 X 8.1/2.	10